



Complementary Low-Threshold MOSFET Pair



Pb-free
Available

PRODUCT SUMMARY			
	V_{DS} (V)	$r_{DS(on)}$ (Ω)	I_D (A)
N-Channel	20	0.385 @ $V_{GS} = 4.5$ V	0.70
		0.630 @ $V_{GS} = 2.5$ V	0.54
P-Channel	-8	0.600 @ $V_{GS} = -4.5$ V	-0.60
		0.850 @ $V_{GS} = -2.5$ V	-0.50
		1.200 @ $V_{GS} = -1.8$ V	-0.42

FEATURES

- TrenchFET® Power MOSFET

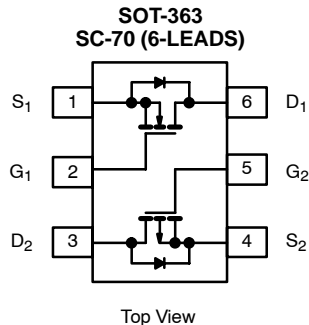

Marking Code

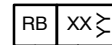

Lot Traceability
and Date Code

Part # Code

Ordering Information: Si1555DL-T1
Si1555DL-T1—E3 (Lead (Pb)-Free)

ABSOLUTE MAXIMUM RATINGS ($T_A = 25^\circ\text{C}$ UNLESS OTHERWISE NOTED)							
Parameter	Symbol	N-Channel		P-Channel		Unit	
		5 secs	Steady State	5 secs	Steady State		
Drain-Source Voltage	V_{DS}	20		-8		V	
Gate-Source Voltage	V_{GS}	± 12		± 8			
Continuous Drain Current ($T_J = 150^\circ\text{C}$) ^a	I_D	$T_A = 25^\circ\text{C}$	± 0.70	± 0.66	-0.60	-0.57	A
		$T_A = 85^\circ\text{C}$	± 0.50	± 0.48	-0.43	-0.41	
Pulsed Drain Current	I_{DM}	± 1.0					
Continuous Source Current (Diode Conduction) ^a	I_S	0.25	0.23	-0.25	-0.23		
Maximum Power Dissipation ^a	P_D	$T_A = 25^\circ\text{C}$	0.30	0.27	0.30	0.27	W
		$T_A = 85^\circ\text{C}$	0.16	0.14	0.16	0.14	
Operating Junction and Storage Temperature Range	T_J, T_{stg}	-55 to 150				$^\circ\text{C}$	

THERMAL RESISTANCE RATINGS					
Parameter		Symbol	Typical	Maximum	Unit
Maximum Junction-to-Ambient ^a	$t \leq 5$ sec	R_{thJA}	360	415	$^\circ\text{C/W}$
	Steady State		400	460	
Maximum Junction-to-Foot (Drain)	Steady State	R_{thJF}	300	350	

Notes

a. Surface Mounted on 1" x 1" FR4 Board.

SPECIFICATIONS (T _J = 25 °C UNLESS OTHERWISE NOTED)							
Parameter	Symbol	Test Condition		Min	Typ	Max	Unit
Static							
Gate Threshold Voltage	V _{GS(th)}	V _{DS} = V _{GS} , I _D = 250 μA	N-Ch	0.6		1.4	V
		V _{DS} = V _{GS} , I _D = -250 μA	P-Ch	-0.45		-1.0	
Gate-Body Leakage	I _{GSS}	V _{DS} = 0 V, V _{GS} = ±12 V	N-Ch			±100	nA
		V _{DS} = 0 V, V _{GS} = ±8 V	P-Ch			±100	
Zero Gate Voltage Drain Current	I _{DSS}	V _{DS} = 20 V, V _{GS} = 0 V	N-Ch			1	μA
		V _{DS} = -8 V, V _{GS} = 0 V	P-Ch			-1	
		V _{DS} = 20 V, V _{GS} = 0 V, T _J = 85 °C	N-Ch			5	
		V _{DS} = -8 V, V _{GS} = 0 V, T _J = 85 °C	P-Ch			-5	
On-State Drain Current ^a	I _{D(on)}	V _{DS} ≥ 5 V, V _{GS} = 4.5 V	N-Ch	1.0			A
		V _{DS} ≤ -5 V, V _{GS} = -4.5 V	P-Ch	-1.0			
Drain-Source On-State Resistance ^a	r _{DS(on)}	V _{GS} = 4.5 V, I _D = 0.66 A	N-Ch		0.320	0.385	Ω
		V _{GS} = -4.5 V, I _D = -0.57 A	P-Ch		0.510	0.600	
		V _{GS} = 2.5 V, I _D = 0.40 A	N-Ch		0.560	0.630	
		V _{GS} = -2.5 V, I _D = -0.48 A	P-Ch		0.720	0.850	
		V _{GS} = -1.8 V, I _D = -0.20 A	P-Ch		1.00	1.200	
Forward Transconductance ^a	g _{fs}	V _{DS} = 10 V, I _D = 0.66 A	N-Ch		1.5		S
		V _{DS} = -4 V, I _D = -0.57 A	P-Ch		1.2		
Diode Forward Voltage ^a	V _{SD}	I _S = 0.23 A, V _{GS} = 0 V	N-Ch		0.8	1.2	V
		I _S = -0.23 A, V _{GS} = 0 V	P-Ch		-0.8	-1.2	
Dynamic^b							
Total Gate Charge	Q _g	N-Channel V _{DS} = 10 V, V _{GS} = 4.5 V, I _D = 0.66 A P-Channel V _{DS} = -4 V, V _{GS} = -4.5 V, I _D = -0.57 A	N-Ch		0.8	1.2	nC
Gate-Source Charge	Q _{gs}		N-Ch		0.06		
			P-Ch		0.17		
Gate-Drain Charge	Q _{gd}	N-Ch		0.30			
		P-Ch		0.16			
Turn-On Delay Time	t _{d(on)}	N-Channel V _{DD} = 10 V, R _L = 20 Ω I _D ≅ 0.5 A, V _{GEN} = 4.5 V, R _g = 6 Ω P-Channel V _{DD} = -4 V, R _L = 8 Ω I _D ≅ -0.5 A, V _{GEN} = -4.5 V, R _g = 6 Ω	N-Ch		10	20	ns
Rise Time	t _r		N-Ch		16	30	
			P-Ch		25	50	
Turn-Off Delay Time	t _{d(off)}		N-Ch		10	20	
			P-Ch		10	20	
Fall Time	t _f		N-Ch		10	20	
			P-Ch		10	20	
Source-Drain Reverse Recovery Time	t _{rr}		I _F = 0.23 A, di/dt = 100 A/μs	N-Ch		20	
		I _F = -0.23 A, di/dt = 100 A/μs	P-Ch		20	40	

Notes

- a. Pulse test; pulse width ≤ 300 μs, duty cycle ≤ 2%.
b. Guaranteed by design, not subject to production testing.

Stresses beyond those listed under "Absolute Maximum Ratings" may cause permanent damage to the device. These are stress ratings only, and functional operation of the device at these or any other conditions beyond those indicated in the operational sections of the specifications is not implied. Exposure to absolute maximum rating conditions for extended periods may affect device reliability.



TYPICAL CHARACTERISTICS (25°C UNLESS NOTED) N-CHANNEL

Output Characteristics

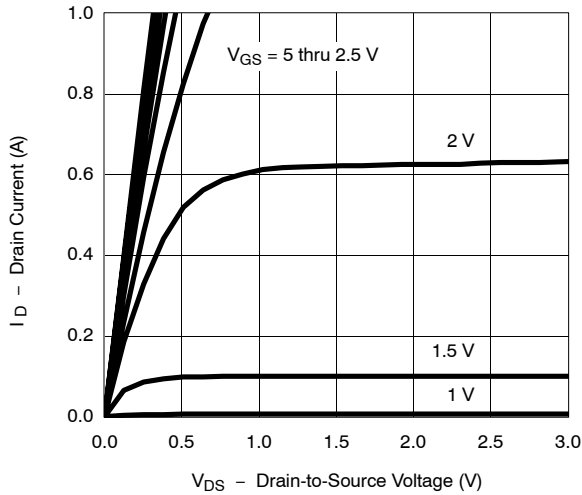

Transfer Characteristics

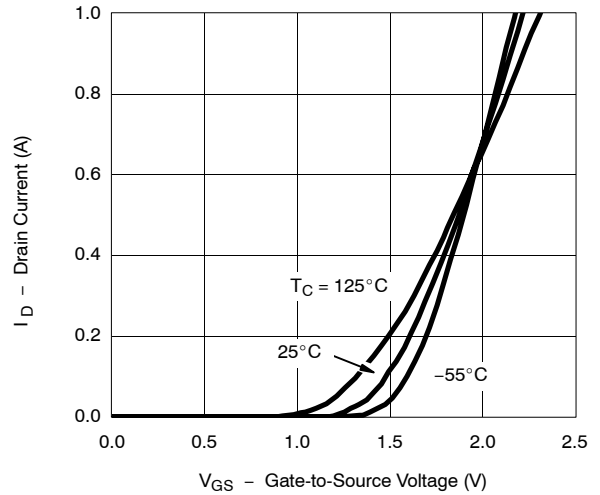

On-Resistance vs. Drain Current

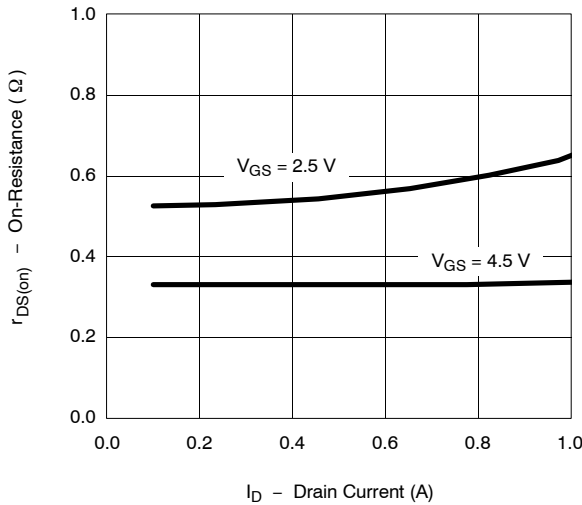

Capacitance

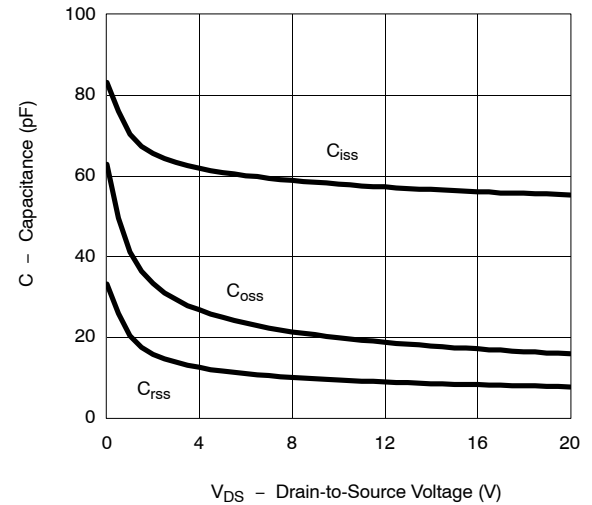

Gate Charge

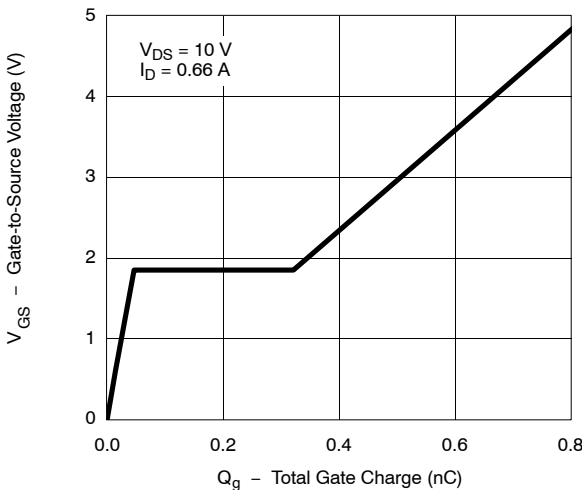

On-Resistance vs. Junction Temperature

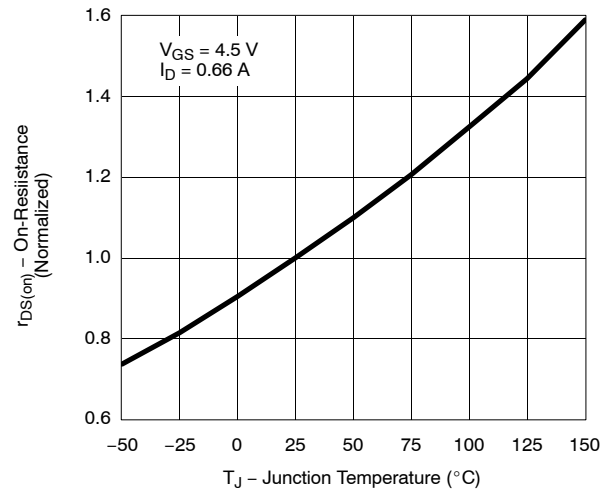

TYPICAL CHARACTERISTICS (25 °C UNLESS NOTED) N-CHANNEL

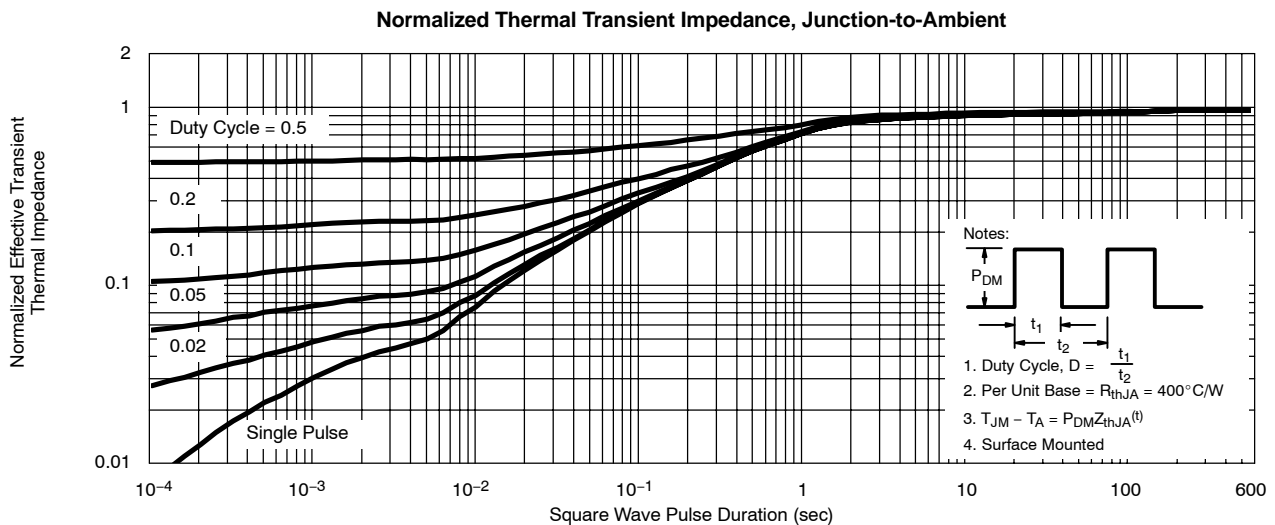
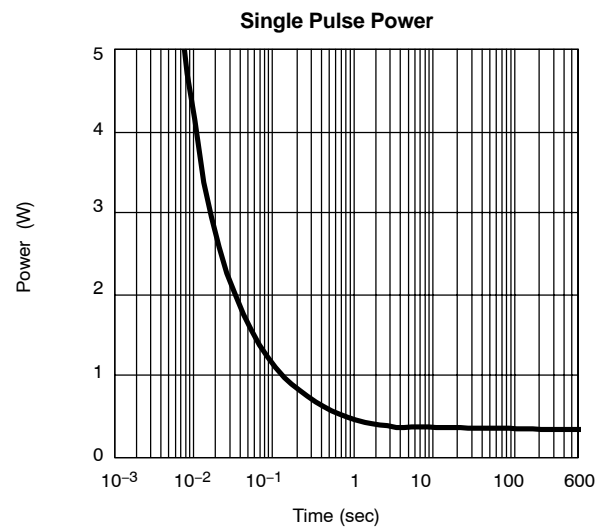
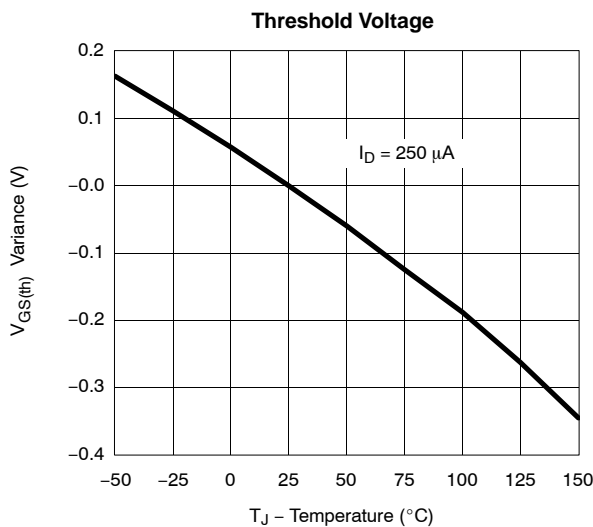
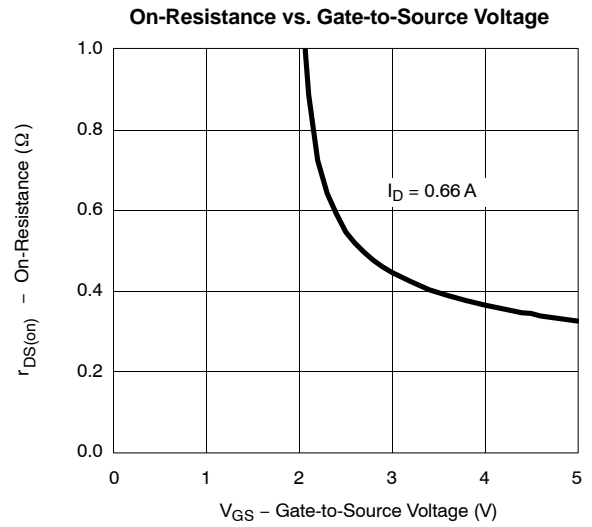
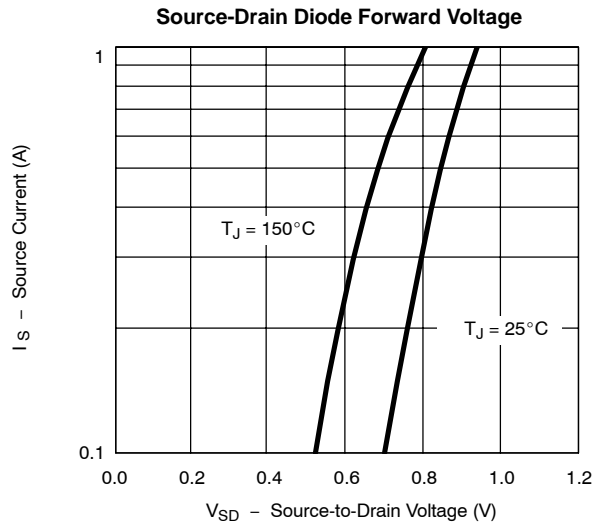



TYPICAL CHARACTERISTICS (25 °C UNLESS NOTED)

N-CHANNEL

Normalized Thermal Transient Impedance, Junction-to-Foot

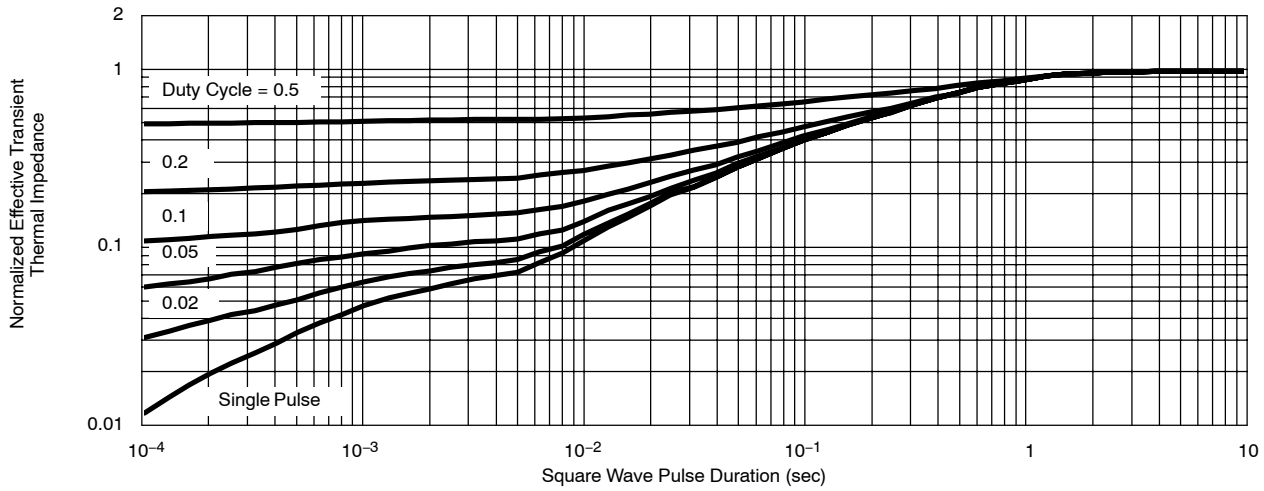

TYPICAL CHARACTERISTICS (25 °C UNLESS NOTED)

P-CHANNEL

Output Characteristics

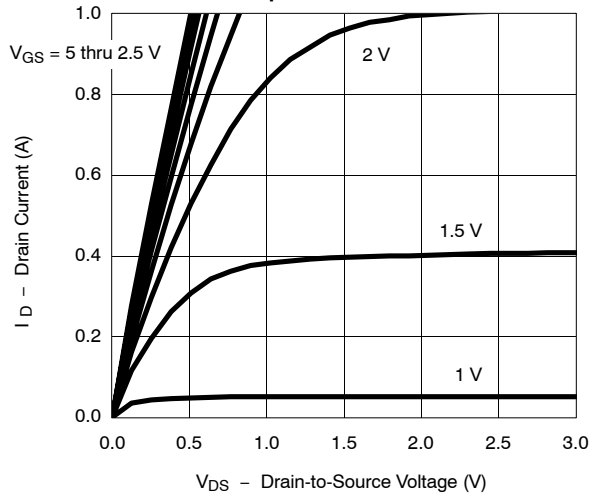

Transfer Characteristics

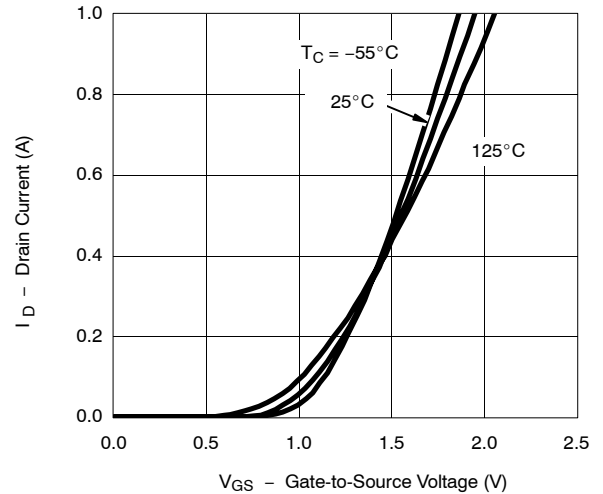

On-Resistance vs. Drain Current

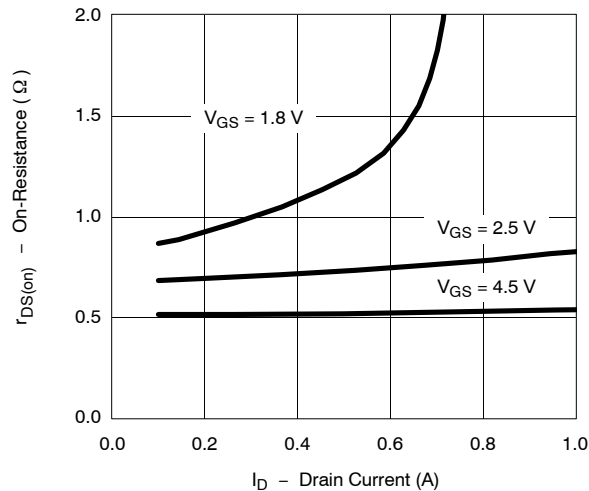

Capacitance

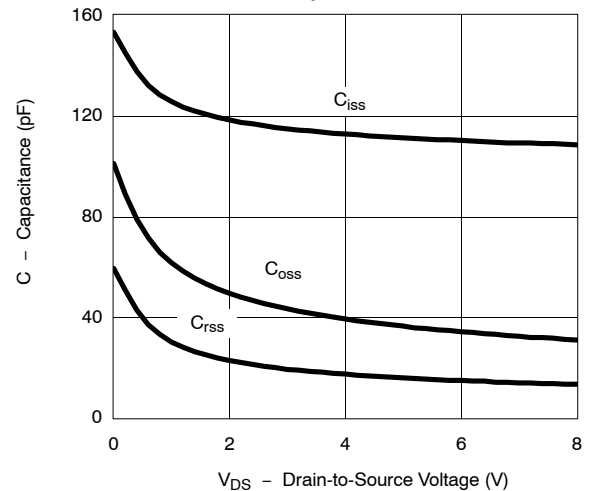

TYPICAL CHARACTERISTICS (25 °C UNLESS NOTED) P-CHANNEL

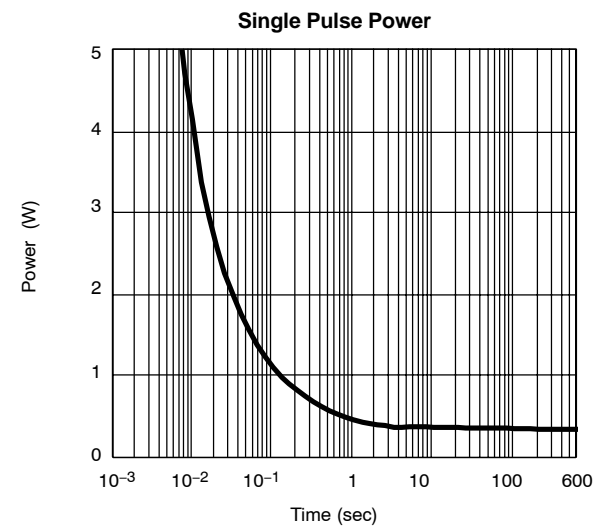
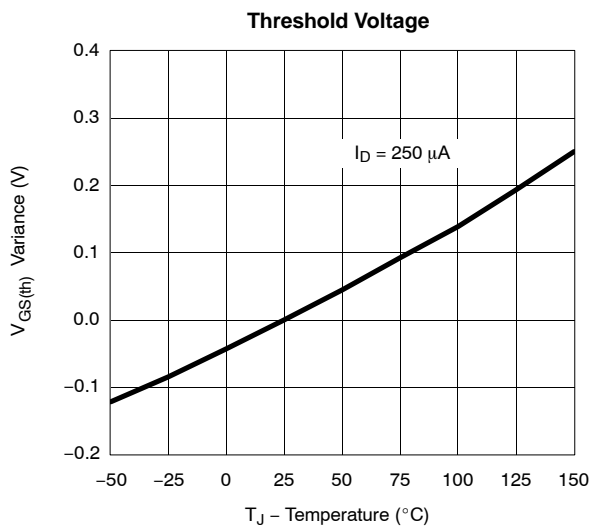
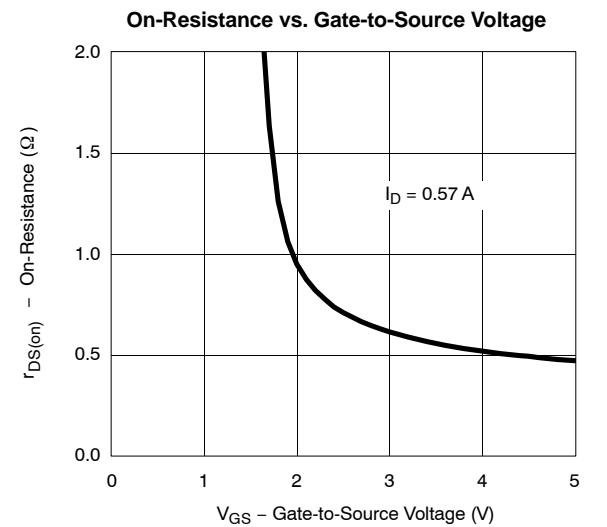
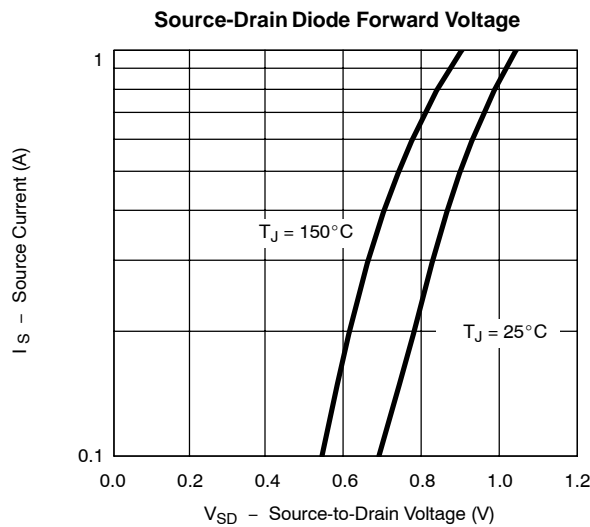
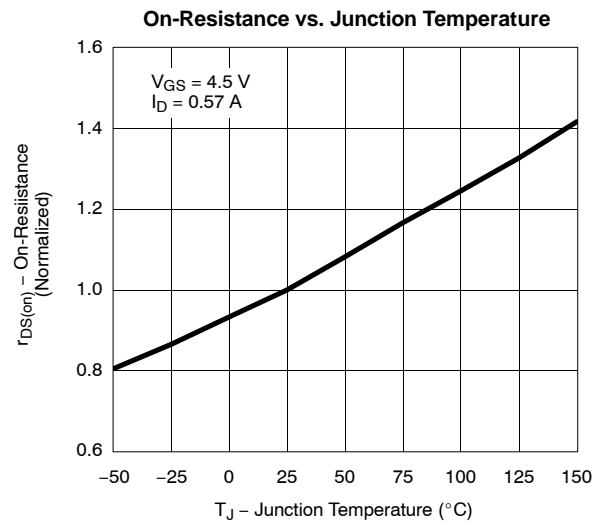
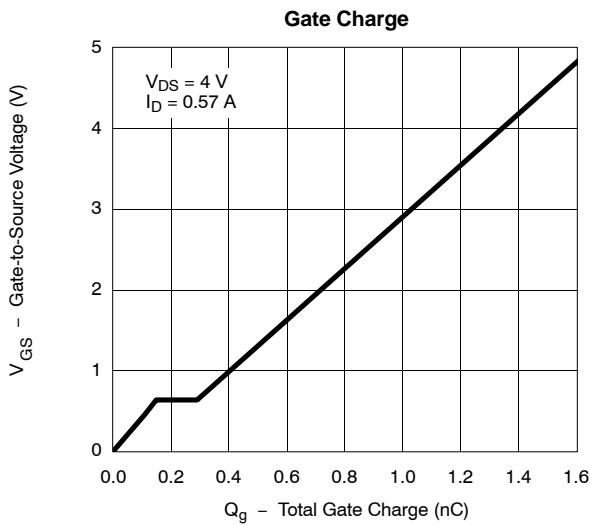

TYPICAL CHARACTERISTICS (25°C UNLESS NOTED) P-CHANNEL

Normalized Thermal Transient Impedance, Junction-to-Ambient

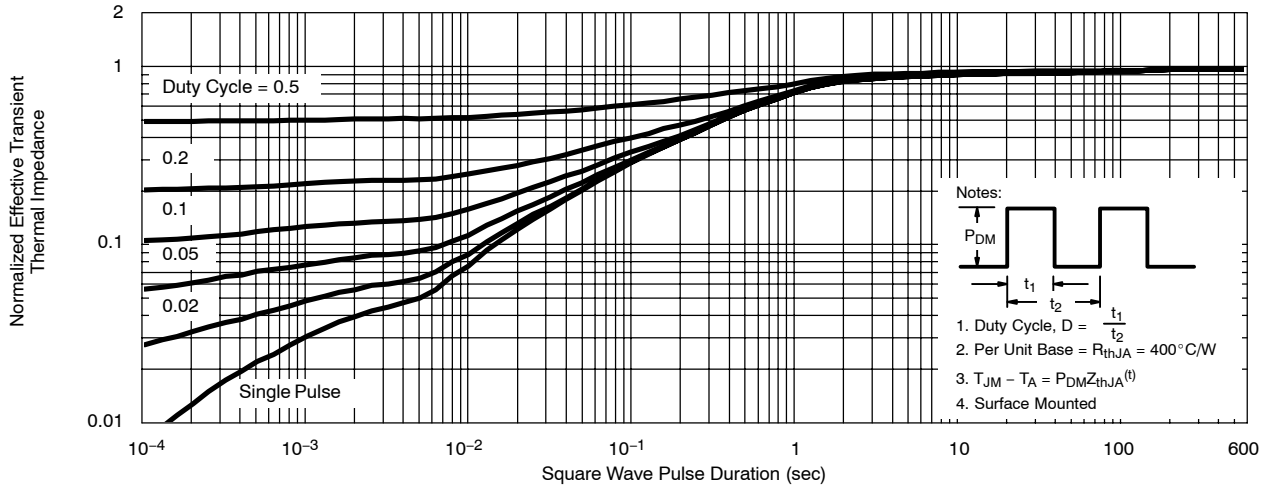

Normalized Thermal Transient Impedance, Junction-to-Foot

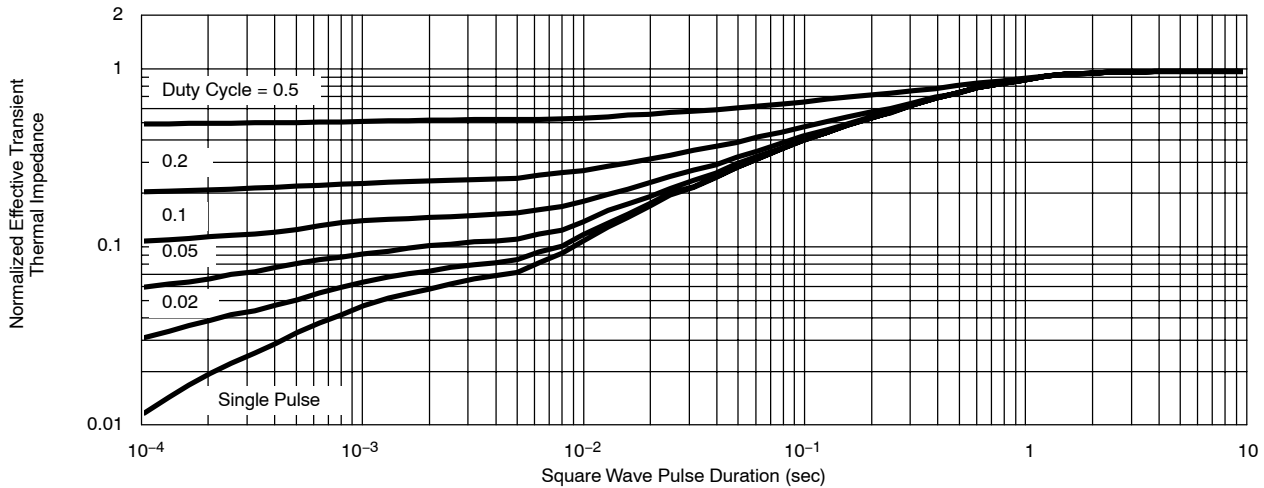

Vishay Siliconix maintains worldwide manufacturing capability. Products may be manufactured at one of several qualified locations. Reliability data for Silicon Technology and Package Reliability represent a composite of all qualified locations. For related documents such as package/tape drawings, part marking, and reliability data, see <http://www.vishay.com/ppg?71079>.



Disclaimer

All product specifications and data are subject to change without notice.

Vishay Intertechnology, Inc., its affiliates, agents, and employees, and all persons acting on its or their behalf (collectively, "Vishay"), disclaim any and all liability for any errors, inaccuracies or incompleteness contained herein or in any other disclosure relating to any product.

Vishay disclaims any and all liability arising out of the use or application of any product described herein or of any information provided herein to the maximum extent permitted by law. The product specifications do not expand or otherwise modify Vishay's terms and conditions of purchase, including but not limited to the warranty expressed therein, which apply to these products.

No license, express or implied, by estoppel or otherwise, to any intellectual property rights is granted by this document or by any conduct of Vishay.

The products shown herein are not designed for use in medical, life-saving, or life-sustaining applications unless otherwise expressly indicated. Customers using or selling Vishay products not expressly indicated for use in such applications do so entirely at their own risk and agree to fully indemnify Vishay for any damages arising or resulting from such use or sale. Please contact authorized Vishay personnel to obtain written terms and conditions regarding products designed for such applications.

Product names and markings noted herein may be trademarks of their respective owners.